

SIEMENS



Sitraffic Sensus Unit C3077

Instruction Manual

Edition: 06 / 2016

C97158-C3077-C148-01-N9

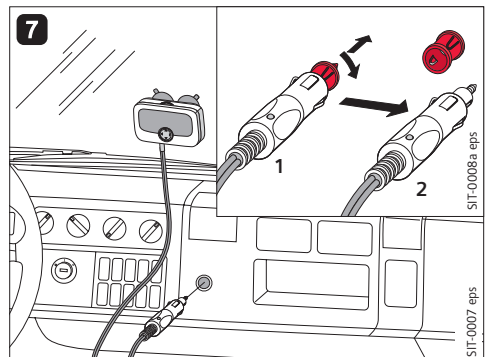
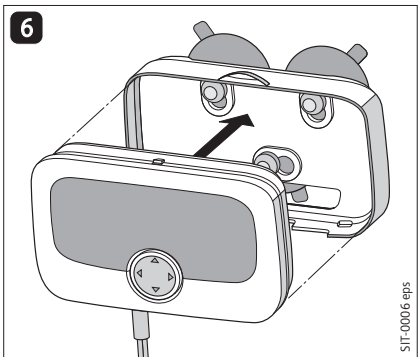
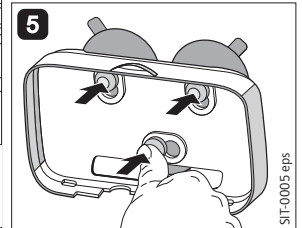
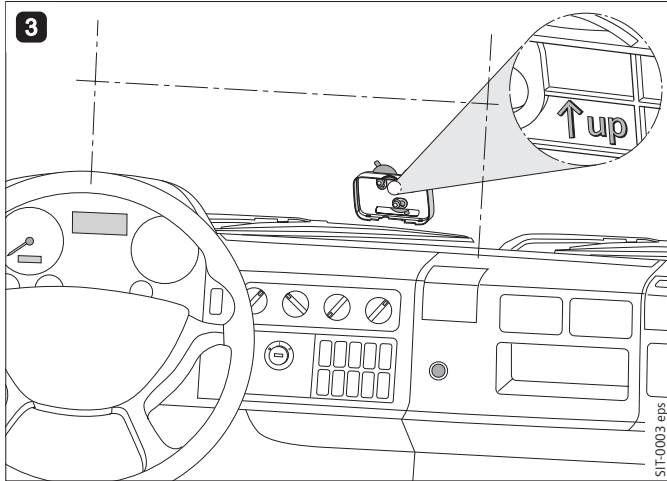
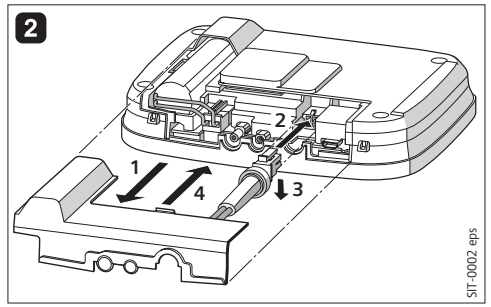
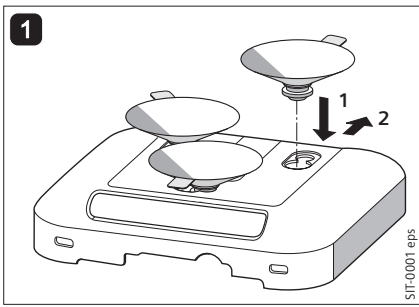

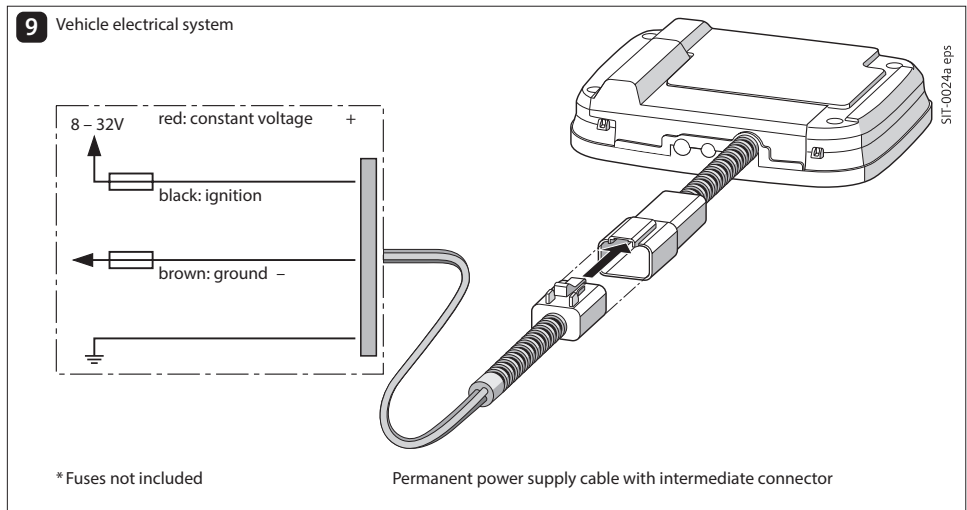
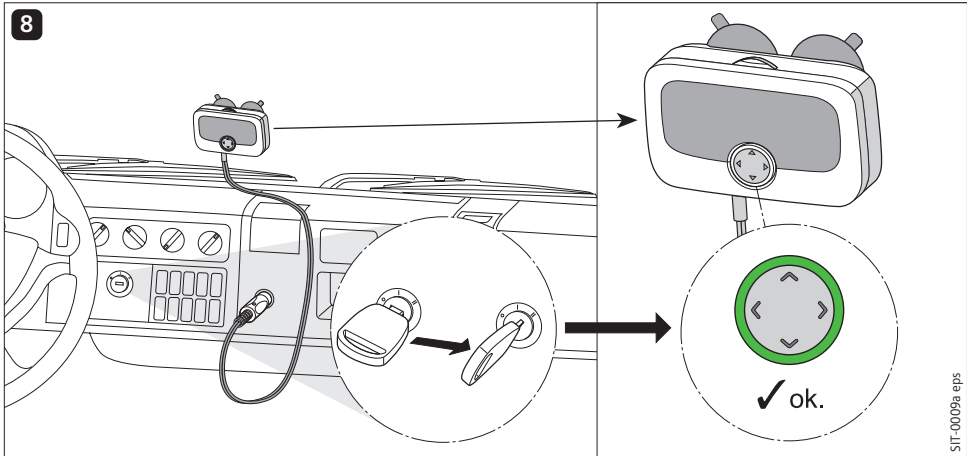



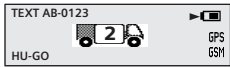
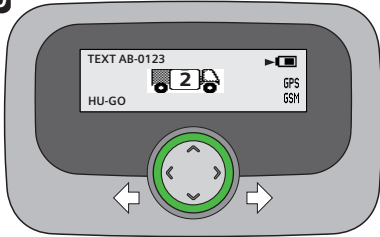



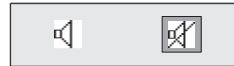
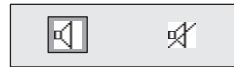
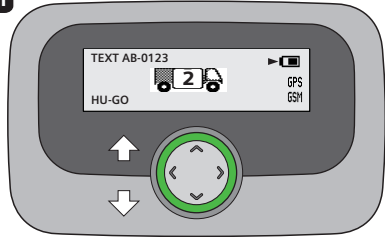







10



11



Display icons	Description
 	Displays availability of GSM
 	Displays availability of GPS
HU-GO 	HU-GO: activated / temporarily disabled
	Sitraffic Sensus Unit connected to the external power supply and battery charging
	Sitraffic Sensus Unit operated from the battery
	Sitraffic Sensus Unit operated from the battery and the battery is low (symbol is blinking)
	USB correctly connected
	USB correctly connected but connection to electronic toll operator failed
	Defect
	Commercial lock
	Battery missing / defect
	Transport mode



Information related to the content of the instruction manual

This manual reflects the state as at the time of downloading. Please check from time to time if an updated version is available on web page www.siemens.com/mobility-sensusunit-manuals.

Siemens Aktiengesellschaft Österreich ("Siemens") reserves the right to make changes to specifications, descriptions, operation instructions and figures in this manual. This manual does not contain nor regulate the vehicle operator/driver rights and obligations related to electronic toll collection stipulated by the relevant legal acts.

This manual is subject to the copyright of Siemens. No part of this manual may be reproduced in any manner without the prior express approval of Siemens.

Disclaimer

Intended use of Sitraffic Sensus Unit is the electronic toll collection and other telematic services, if not explicitly stated otherwise. Siemens shall not be held liable for any damages caused by non intended or any improper use of the Sitraffic Sensus Unit, especially any personal injury, any damage at property or any financial loss.

Contents

1	Symbols used in this manual	8
2	Notes on safety	8
3	Intended use	8
4	General instructions	9
5	Verifying the Sitraffic Sensus Unit package contents	10
6	Installation types	10
7	Installation in vehicles transporting dangerous goods (ADR vehicles)	11
8	Mounting and installing the Sitraffic Sensus Unit	11
9	User interface	14
10	Operation	15
11	Removal	21
12	Available accessories	22
13	Permanent installation	22
14	Technical data	24
15	Declaration of conformity	25

1 Symbols used in this manual

**Danger**

Symbol and words refer to dangerous situations which could lead to serious injury or death.

**Remark**

Symbol and words refer to additional information which you should pay attention to.

**Reference**

The number in the symbol refers to the related figure at the beginning of this manual.

**Caution**

Symbol and words refer to dangerous situations which could lead to damage of the device or other property.

2 Notes on safety

***Danger of accident!***

Do not handle the Sittraffic Sensus Unit while driving.

***Danger of fire!***

A damaged power supply cable can cause fire by short circuits. Replace damaged power supply cables immediately!

3 Intended use



The Sittraffic Sensus Unit is intended to be used for electronic toll collection and other telematic services, if not explicitly stated otherwise, and may only be used for this purpose. Any other use is considered to be a prohibited misuse and would result in the denial of any claims.

4 General instructions



Destruction caused by over-voltage!

The Sitraffic Sensus Unit is designed for a voltage range of 8 – 32 V DC and must therefore not be used outside this voltage range. If your on-board network can generate higher voltages (e.g. jump-starting from an external power source or from additional stronger power generators in the vehicle), then you must disconnect the unit from the on-board network for the duration of the over-voltage.



Damage caused by incorrect cleaning!

The unit may be cleaned when required with a damp cloth. Do not use any volatile solvents, e.g. alcohol and do not use abrasive cleaning agents.



Damage caused by incorrect handling!

The Sitraffic Sensus Unit is an electronic device and therefore you should avoid excessive impact forces. Do not operate the unit with pointed or sharp objects.

5 Verifying the Sitraffic Sensus Unit package contents

The Sitraffic Sensus Unit package contains:

1. One Sitraffic Sensus Unit including rechargeable battery
2. One power supply cable for cigarette lighter installation, with LED power supply indication on the connector
3. One plastic bag including holder and one cleaning cloth
4. Three suction cups
5. One Installation and Safety Instructions leaflet (for once may be handed out separately).



Please check if the package content is complete and undamaged. If you find something missing or damaged, please claim at after-sales service of your operating company immediately!

6 Installation types

There are two possible installation types:

- Temporary installation – In this case the Sitraffic Sensus Unit is powered from the cigarette lighter socket.
- Permanent installation – In this case the Sitraffic Sensus Unit is connected to the vehicle electrical system by an optional available power supply cable with intermediate connector.

This manual describes both installation types which can be used alternatively depending on the available accessories. The permanent installation will be described in chapter 13.

7 Installation in vehicles transporting dangerous goods (ADR vehicles)



Danger of explosion! Installation in ADR vehicle is a case for fixed installation and must only be performed by authorised staff! If you wish to install the device into an ADR vehicle please contact the after-sales service of your operating company for support.

8 Mounting and installing the Sitraffic Sensus Unit

Mounting the suction cups to the holder



Attach the provided suction cups to the holder as shown in the related figure.

Connecting the power cable to the Sitraffic Sensus Unit



1. Remove the connector panel cover of the device.
2. Plug the provided power supply cable into the power socket and make sure that the plug's snap catch has engaged.
3. Make sure that the rubber tube of the provided power supply cable is located at the right position.
4. Close the device again with the connector panel cover.



Danger of fire and malfunction!

Always protect the power supply cable against mechanical forces and other negative factors (e.g. extensive heat, aggressive chemicals) which could lead to destruction of isolation and short circuits.
Replace damaged cables immediately!

Determine the Sitraffic Sensus Unit mounting location

Determine the mounting location on the inside of the windscreen such that:

3

- the driver's field of vision is not impaired while driving,
- the chosen position must not be near moving parts e.g. air bag covers of the vehicle,
- the Sitraffic Sensus Unit is visible from outside and is not hidden by other elements such as windscreen wipers when off,
- the Sitraffic Sensus Unit does not constrain the function of the defroster vents,
- in the case of metalized windscreen use non-metalized area,
- local laws and regulations as well as recommendations of the vehicle manufacturer are complied with.

In case of doubts please contact the after-sales service of your operating company for support.



Danger of accident!

Always mount the Sitraffic Sensus Unit in such way that driver's field of vision is not impaired!

Attaching the holder to the windscreen

4

1. The determined location on the windscreen and the contact surface of the suction cups must be clean, dry and free from oil and grease. If necessary, carefully clean with the supplied cleaning cloth and wait until the surface is dry before to proceed with the next step.

5

2. Attach the holder at the chosen position with the suction cups. Press firmly at the centre of each suction cup.



When using the suction cups you must check for correct fitting before each journey.



The service life of the suction cups is typically 6 months if the suction cups are used on the windscreen.

Assembling the device and its holder



1. Close the gap between the Sitraffic Sensus Unit and holder until you hear a clicking sound.
2. Check the connection by trying to tear apart the holder and the Sitraffic Sensus Unit.

Connecting the Sitraffic Sensus Unit to the external power supply



7. Connect the Sitraffic Sensus Unit power supply cable for temporary installation to the cigarette lighter socket (or DIN socket) as shown in the figure.

It is recommended to use the DIN socket to plug in the cigarette lighter connector of the power cable. The DIN socket in the vehicle is recognizable by the smaller diameter of the socket compared to a conventional one. To use this socket you have to remove the red cap of the connector by twisting it to the left. Then plug the cigarette lighter connector into the DIN socket.

Don't remove the red cap if you use a conventional cigarette lighter socket. You can immediately plug the cigarette lighter connector into the cigarette lighter socket.



The Sitraffic Sensus Unit may only be connected to voltages of between 8 and 32 V DC. Ignoring this warning could lead to serious damages of the device and will cause a decline of guarantee claims.



Fix the power supply cable in such a way that it cannot become disconnected while driving the vehicle or otherwise negatively affects the vehicle operation.

9 User interface

The Sittraffic Sensus Unit informs you through its user interface permanently about its status, provides the means for all necessary settings and gives you the feed back to user interaction.

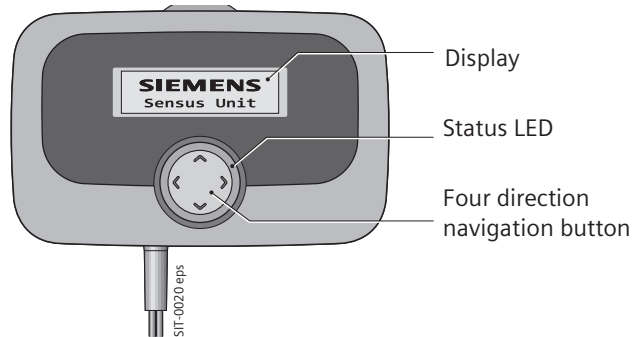

User interface comprises the following elements:

1. Display – for displaying of the operational status and settings.
2. Four direction navigation button – for:
 - setting of the axles number
 - enabling or disabling of acoustic signalization
 - forcing communication with central system.
3. Overall status LED – for indication of overall Sittraffic Sensus Unit status.
4. Beeper – for acoustic:
 - signalization of performed actions
 - feedback to user interactions
 - signalization of number of axles on startup.

10 Operation



Danger of accident!

Do not try to handle the Sitraffic Sensus Unit while driving.

Switching on the Sitraffic Sensus Unit



The Sitraffic Sensus Unit does not have a power on or off switch. By connecting the Sitraffic Sensus Unit to the power supply it starts to operate and shows the battery symbol in the upper right of the display. In case the Sitraffic Sensus Unit is already connected it starts:

- when the ignition is turned on or
- when the vehicle starts to move.

Sitraffic Sensus Unit in operation

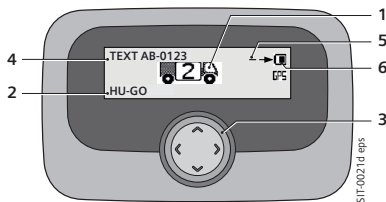

- 1 Number of axles
- 2 Activated toll services
- 3 Status LED
- 4 Licence plate number
- 5 Connection to external power supply
- 6 Battery status

Selecting the number of axles



Before starting a trip on the tollable road network you have to set the proper number of axles, if it differs from initial declaration. The initial configuration and activation of the device is done by the after-sales service of your operating company.



Please check if the information shown on the display is correct (e.g. license plate number, number of axles).



At the beginning of this manual you can find an overview of changing the number of axles (2, 3, ... 14 axles), whereas the settings have to be chosen according to the legislation in force. Please contact the after-sales service of your operating company for further information.

Use the navigation key and long press “◀” or “▶” repeatedly, until the number of axles in the symbol matches to your vehicle (or semi-trailer unit). The number of axles within the lorry symbol and the status LED are blinking (the latter in yellow) until a confirmation is sent by the back office.

On receipt of acknowledgement, the selected number of axles within the lorry symbol turns stable and the LED shows permanently green. Thus the correct settings of the number of axles are enabled in the Sittraffic Sensus Unit.



This process can take a while and you may choose to get in contact with the after-sales service of the operating company to notify the axle change using a different methodology (e.g. SMS).

In case HU-GO is activated, the status LED is green and the correct number of axles set, the Sittraffic Sensus Unit is ready for use in the HU-GO toll domain.

Enabling / Disabling of acoustic signalization

The Sittraffic Sensus Unit has an integrated speaker where some of the acoustic signals can be switched off (see table “acoustic signalization”).



Use the navigation key and press “▼” or “▲” until the speaker symbol appears.
Use the navigation key and press “◀” or “▶” to enable or disable the speaker.

Display of information screen

The Sittraffic Sensus Unit offers the possibility to display information about the used version.







Use the navigation key and press “▼” or “▲” until the information symbol appears.
Use the navigation key and press “▶” to display the information about the version, press “▼” or “▲” for further information.

After accomplishing your selection you can change to the normal operation screen by pressing twice “◀”, respectively the screen turns automatically to the normal operations screen after some time.

Battery and connection to external power supply status

The normal operations mode requires the Sittraffic Sensus Unit to be connected to vehicle power supply. Nevertheless the Sittraffic Sensus Unit has an integrated battery that keeps the Sittraffic Sensus Unit operational even during short power outages of the vehicle. The display informs you about the operation status of the battery and an arrow in front of battery symbol indicates connection to the external power supply:

	Sitraffic Sensus Unit connected to the external power supply and battery charging
	Sitraffic Sensus Unit connected to the external power supply and battery defect or missing
	Sitraffic Sensus Unit operated from the battery
	Sitraffic Sensus Unit operated from the battery and the battery is low (symbol is blinking)

When Sitraffic Sensus Unit is disconnected from external power supply, it indicates this fact additionally to display also by status LED and acoustically. In this case status LED is periodically after 5 minutes switched off for 5 seconds and every 5 minutes Sitraffic Sensus Unit beeps shortly. When battery reaches low level, status LED change interval for cyclic changes to 5 seconds off and 10 seconds on.

 In the case that Sitraffic Sensus Unit indicates operation from the battery, check the power supply cable and fuse in connector and try to reestablish the power supply.



Activation of toll services

Toll services HU-GO will be activated by your operating company as part of the handover.



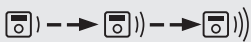

Forcing a transmission

You may be required to force the Sitraffic Sensus Unit to transmit data (on request). For this procedure please press on the navigation button “▲” for more than 2 seconds, until you hear a double beep from the speaker confirming the acceptance of the procedure.

You will see in the left down corner of the display the connection attempt and get back the result of communication.

	Displaying of connection attempt
	Transmission successful
	Transmission failed

Sitraffic Sensus Unit operational status

Operational status	Status LED	Display	Description
ACTIVE	 Green		This is the normal operation state of the HU-GO service. In the middle of the display the selected number of axles is shown.
WARNING	 Yellow blinking		A yellow blinking status LED indicates, that the Sitraffic Sensus Unit is in warning state, currently not ready for HU-GO tolling, e.g. no GPS.
DEFECT or COMMERCIAL LOCK	 Red	 or  in the middle of the display	If the Sitraffic Sensus Unit is not ready for use this is indicated by a warning triangle in case of a technical defect or a lock symbol in case of a commercial lock in the middle of the display.



If the status LED is red, the Sitraffic Sensus Unit is not ready to use and you are not allowed to use the HU-GO road network. In this case contact immediately the after-sales service of your operating company.



If the status LED is blinking yellow, the Sitraffic Sensus Unit is in warning state, currently not ready for HU-GO tolling, e.g. no GPS.

Transport mode

Transport mode is used when transportation of the Sitraffic Sensus Unit is needed without charging for usage of the tolled road network. It can be enabled in conjunction with the handover procedure or on request by calling the after-sales service of your operating company. This mode is indicated by the following symbol shown in the right down corner of the display and becomes active after disconnect from power supply.





Sitraffic Sensus Unit update















The Sitraffic Sensus Unit may require software updates which are distributed remotely automatically. During start up the Sitraffic Sensus Unit may execute this procedure, showing the progress on the display. Wait until update procedure is completed. After the update is completed the Sitraffic Sensus Unit returns to normal operation mode.

Acoustic signalization

The Sitraffic Sensus Unit is designed to give you acoustic notification (in case the speaker operation is enabled) for events that may occur during operation of the Sitraffic Sensus Unit.

Event	Tone	Repetition	Configurable
Startup – at least one toll service activated	No. of axles	1 x	no
Startup w/o any toll service activated		1 x	
Shutdown		1 x	

Event	Tone	Repetition	Configurable
Activation		1 x	
External power disconnected (more than 20 minutes operation possible)		every 5 minutes	no
Battery low (less than 20 minutes operation possible)		every 5 minutes	no
External power reconnected		1 x	
GPS currently not available or operating temperature range exceeded or geodata expired		every 60 seconds	
Commercial locked or Defect		every 15 seconds	
Fatal error		1 x	no
Key pressed		1 x	
Invalid key press		1 x	
Axles change	No. of axles	1 x	
Speaker ON		1 x	no
Speaker OFF		1 x	no
Successful data transmission confirmation		1 x	

No. of axles	Tone	Repetition	Configurable
2, 3 or 4 axles		1 x	no
5, 6, ... 9 axles		1 x	no
10, 11, ... 14 axles		1 x	no

11 Removal

Disconnecting the power supply

Disconnect the power supply cable from the cigarette lighter. If the red cap of the cigarette lighter cable is stuck in the socket you can remove it by inserting the connector back into the socket, turning it clockwise about 90° and pull it out again.



The internal power supply connector of the Sitraffic Sensus Unit is not foreseen to be connected and disconnected on a regular basis. For normal operation always disconnect the cigarette lighter cable connector from the cigarette lighter socket (or DIN socket).

Detaching Sitraffic Sensus Unit from the holder

Remove the Sitraffic Sensus Unit from the holder by releasing the latch on the upper side of the holder and pulling the device out of the holder.

Demounting of the Sitraffic Sensus Unit holder

Finally remove the holder of the Sitraffic Sensus Unit.

If you have difficulties to remove the holder as a whole, release the suction cups one by one by pulling the according flap.

Disposal



This appliance is marked in accordance with European Directive 2002/96/EC (waste electrical and electronic equipment – WEEE). By proper disposal you prevent potential consequences for the environment and human health. For detailed information regarding disposal of the device please ask after-sales service of your operating company.

12 Available accessories

The power supply cable for permanent installation is available at the after-sales service of your operating company.



Danger of fire and malfunction!

Always use accessories which are approved for the intended purpose and do not make any changes to them.

13 Permanent installation

Connecting the power supply cable to the vehicle electrical system

9

Connection of the Sittraffic Sensus Unit power supply cable to the vehicle electrical system (as shown in the related figure) has to be done by authorised staff only!



Working on a vehicle (and especially on a vehicle electrical system) can cause danger. All work must be carried out by authorised staff! Always observe the instructions and recommendations of the vehicle manufacturer when working on a vehicle electrical system.

Connecting the Sittraffic Sensus Unit to the external power supply cable

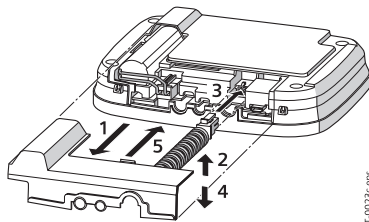

SIT-0023c-eps

1. Remove the connector panel cover of the device.
2. In case of already mounted cable for temporary installation: Make sure that the cable is not connected to the vehicle electrical system and that the plug's snap catch is released when pulling out the connector of the power supply cable.
3. Plug the provided power supply cable into the power socket and make sure that the plug's snap catch has engaged.
4. Make sure that the corrugated tube of the provided power supply cable is located at the right position.
5. Close the device again with the connector panel cover.



Danger of fire and malfunction!

Always protect the power cable against mechanical forces and other negative factors (e.g. extensive heat, aggressive chemicals) which could lead to destruction of isolation and short circuits.

Replace damaged cables immediately!



Fix the power supply cable in such a way that it cannot become disconnected while driving the vehicle or otherwise negatively affects the vehicle operation.

Disconnecting the Sittraffic Sensus Unit from the external power supply



Don't disconnect the plug of the permanent installation cable from the Sittraffic Sensus Unit. For that application, please use the designated intermediate connector instead.



The internal power supply connector of the Sittraffic Sensus Unit is not foreseen to be connected and disconnected on a regular basis. For normal operation always disconnect the permanent power supply cable using the intermediate connector.

14 Technical data

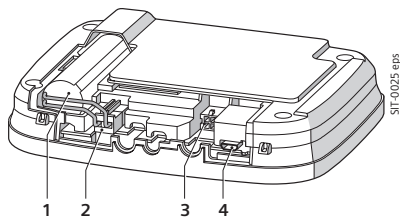

- 1 Rechargeable battery
- 2 Rechargeable battery connector
- 3 Power supply connector
- 4 Service interface

Operating voltage	8 – 32 V DC
Fuse (external)	1 A (in cigarette lighter cable connector) 2 A * (before connecting to vehicle electrical system Term 15 and 30) * fuses not included
Buffer battery	Coin cell with nominal voltage of 3.0 V
Rechargeable battery	Li-Ion with a nominal voltage of 3.6 V and a nominal capacity of 1600 mAh. Charging time: 4 h at 3.0 V to 4.05 V
Power consumption	Power mode "Standby": 25 mW typ. Power mode "Running": 450 mW typ.
GNSS subsystem	12 channel high sensitivity GPS receiver with internal antenna
GSM subsystem	Quad-band GSM module with GPRS (multi-slot class 10) capability
DSRC subsystem	DSRC interface is in accordance with CEN/TC 278
Dimensions	145 × 93 × 36 mm (excluding windscreen mounting bracket)
Weight	260 g (excluding windscreen mounting bracket)

Temperature range	Ambient storage temperature range: -40 °C ... +85 °C according to ISO 16750-4:2006-8 General ambient operating temperature range: -40 °C ... +85 °C according to ISO 16750-4:2006-8, except the GSM subsystem and SAM
Protection class	IP42 according to IEC 60529

15 Declaration of conformity

Siemens AG Österreich herewith declares that Sitraffic Sensus Unit complies with basic requirements and all relevant provisions of the European Directive 1999/5/EC (R&TTE). This device may be operated within the EU.

The firmware in the Sitraffic Sensus Unit includes, among others, free software. Further information on this subject can be obtained from web page:
www.siemens.com/mobility-sensusunit-license

 10R - 04 0012 **The Sitraffic Sensus Unit is a type approved sub-assembly.**

 **0408** **The declaration of Conformity was issued in English language.**

Further information on this subject can be obtained from web page:
www.siemens.com/mobility-sensusunit-certificates

© Siemens Aktiengesellschaft Österreich
All rights reserved
Edition: 06 / 2016

Siemens Aktiengesellschaft Österreich
Siemensstrasse 90
1211 Vienna



C97158-C3077-C148-01-N9